

DATA SHEET

BLV33

VHF linear power transistor

Product specification
Supersedes data of November 1995

1996 Oct 10

VHF linear power transistor

BLV33

FEATURES

- Diffused emitter ballasting resistors for an optimum temperature profile
- Gold sandwich metallization ensures excellent reliability.

APPLICATIONS

- Primarily intended for use in linear VHF amplifiers for television transmitters and transposers.

DESCRIPTION

NPN silicon planar epitaxial transistor encapsulated in a 1/16" 4 fslead SOT147 capstan package with ceramic cap. All leads are isolated from the stud.

PINNING - SOT147

PIN	SYMBOL	DESCRIPTION
1	c	collector
2	e	emitter
3	b	base
4	e	emitter

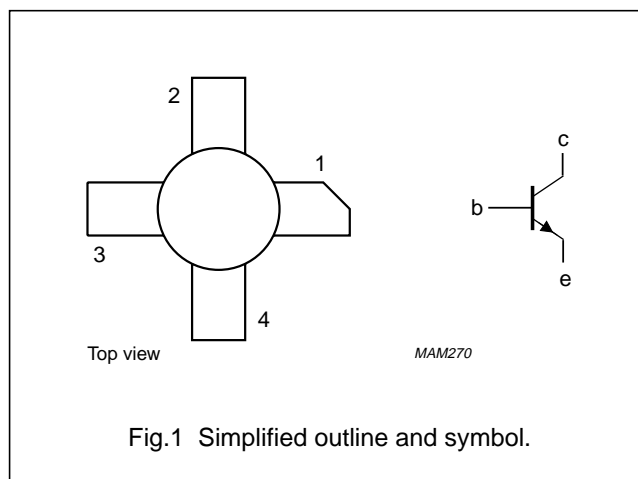

QUICK REFERENCE DATA

RF performance in a common emitter push-pull test circuit.

MODE OF OPERATION	f _{vision} (MHz)	V _{CE} (V)	I _C , I _{C(ZS)} (A)	T _h (°C)	d _{im} ⁽¹⁾ (dB)	P _{o sync} ⁽¹⁾ (W)	G _P (dB)	sync compr. ⁽²⁾ sync in/sync out (%)
CW, class-A	224.25	25	3.2	70	-55	>16.5	>9	
				25	-55	typ. 26	typ. 9.7	
CW, class-AB	224.25	28	0.1	70		typ. 90	typ. 6.5	30/25

Notes

1. Three-tone test method (vision carrier -8 dB, sound carrier -7 dB, sideband signal -16 dB), zero dB corresponds to peak sync level.
2. Television service (negative modulation, C.C.I.R. system).

WARNING
Product and environmental safety - toxic materials
This product contains beryllium oxide. The product is entirely safe provided that the BeO disc is not damaged. All persons who handle, use or dispose of this product should be aware of its nature and of the necessary safety precautions. After use, dispose of as chemical or special waste according to the regulations applying at the location of the user. It must never be thrown out with the general or domestic waste.

VHF linear power transistor

BLV33

LIMITING VALUES

In accordance with the Absolute Maximum Rating System (IEC 134).

SYMBOL	PARAMETER	CONDITIONS	MIN.	MAX.	UNIT
V_{CESM}	collector-emitter voltage	$V_{BE} = 0$	–	65	V
V_{CEO}	collector-emitter voltage	open base	–	33	V
V_{EBO}	emitter-base voltage	open collector	–	4	V
I_C	collector current (DC)		–	12.5	A
$I_{C(AV)}$	average collector current		–	12.5	A
I_{CM}	peak collector current	$f > 1 \text{ MHz}$	–	20	A
P_{tot}	total power dissipation (DC)	$T_{mb} = 25 \text{ }^\circ\text{C}$	–	132	W
P_{rf}	RF power dissipation	$f > 1 \text{ MHz}; T_{mb} = 25 \text{ }^\circ\text{C}$	–	165	W
T_{stg}	storage temperature		–65	+150	$^\circ\text{C}$
T_j	operating junction temperature		–	200	$^\circ\text{C}$

THERMAL CHARACTERISTICS

SYMBOL	PARAMETER	CONDITIONS	VALUE	UNIT
$R_{th\ j-mb(dc)}$	thermal resistance from junction to mounting base (DC dissipation)	$P_{diss} = 80 \text{ W}; T_{mb} = 82 \text{ }^\circ\text{C}; T_h = 70 \text{ }^\circ\text{C}$	1.46	K/W
$R_{th\ j-mb(rf)}$	thermal resistance from junction to mounting base (RF dissipation)	$P_{diss} = 80 \text{ W}; T_{mb} = 82 \text{ }^\circ\text{C}; T_h = 70 \text{ }^\circ\text{C}$	1.17	K/W
$R_{th\ mb-h}$	thermal resistance from mounting base to heatsink	$P_{diss} = 80 \text{ W}; T_{mb} = 82 \text{ }^\circ\text{C}; T_h = 70 \text{ }^\circ\text{C}$	0.15	K/W

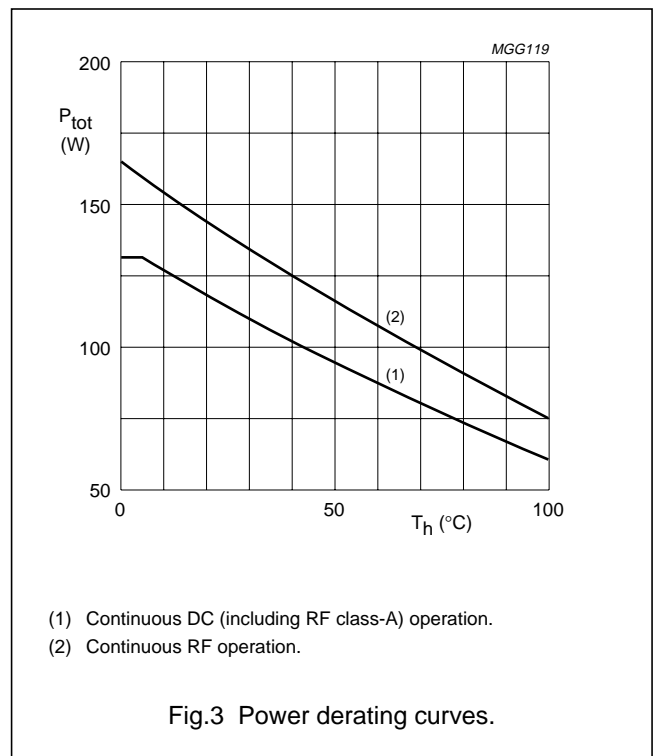
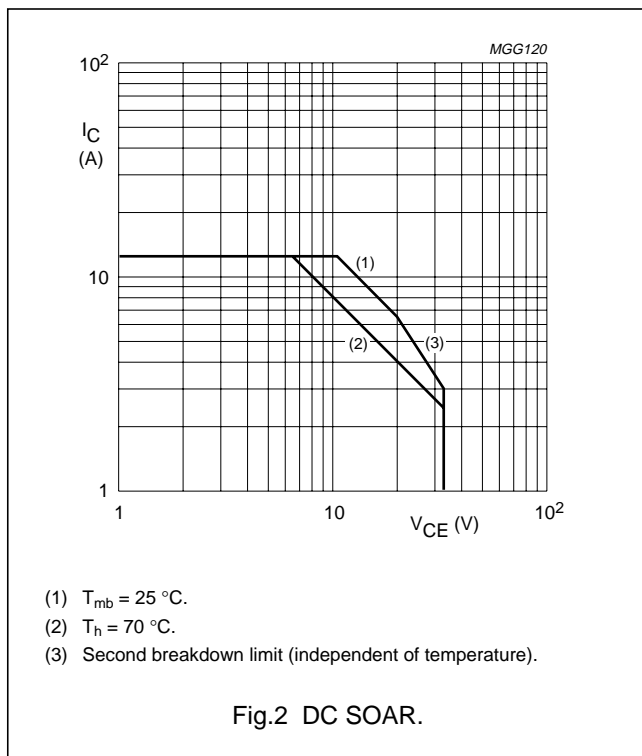

VHF linear power transistor

BLV33

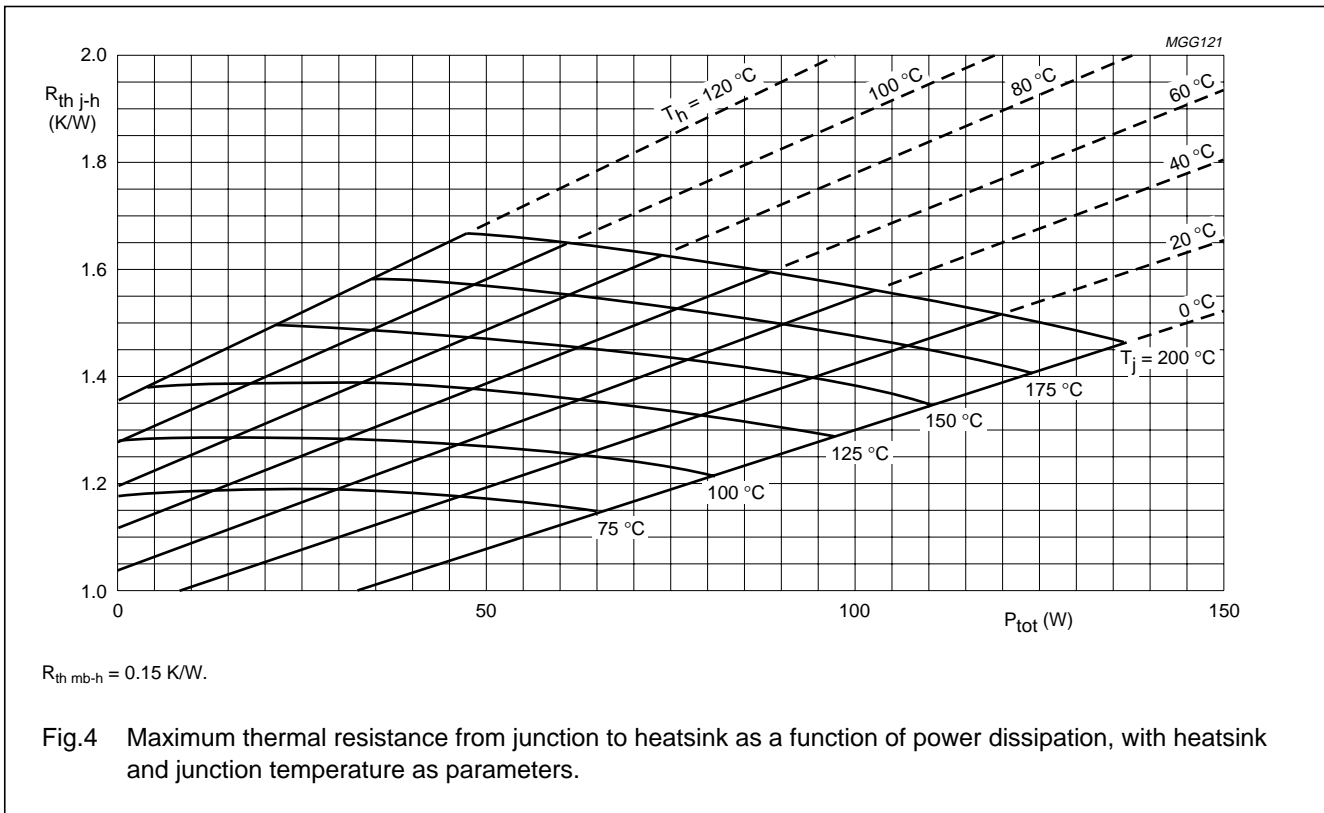

Fig.4 Maximum thermal resistance from junction to heatsink as a function of power dissipation, with heatsink and junction temperature as parameters.

Example

Nominal class-A operation: $V_{CE} = 25\ \text{V}$; $I_C = 3.2\ \text{A}$; $T_h = 70^\circ\text{C}$.

Figure 4 shows:

$R_{th\ j-h} = \text{max. } 1.60\ \text{K/W}$

$T_j = \text{max. } 198^\circ\text{C}$.

Typical device:

$R_{th\ j-h} = \text{typ. } 1.50\ \text{K/W}$

$T_j = \text{typ. } 190^\circ\text{C}$.

VHF linear power transistor

BLV33

CHARACTERISTICS

$T_j = 25\text{ }^\circ\text{C}$; unless otherwise specified.

SYMBOL	PARAMETER	CONDITIONS	MIN.	TYP.	MAX.	UNIT
$V_{(BR)CES}$	collector-emitter breakdown voltage	$V_{BE} = 0$; $I_C = 25\text{ mA}$	65	–	–	V
$V_{(BR)CEO}$	collector-emitter breakdown voltage	open base; $I_C = 100\text{ mA}$	33	–	–	V
$V_{(BR)EBO}$	emitter-base breakdown voltage	open collector; $I_E = 10\text{ mA}$	4	–	–	V
I_{CES}	collector cut-off current	$V_{BE} = 0$; $V_{CE} = 30\text{ V}$	–	–	1	mA
h_{FE}	DC current gain	$V_{CE} = 25\text{ V}$; $I_C = 3\text{ A}$; note 1	15	50	100	
V_{CEsat}	collector-emitter saturation voltage	$I_C = 6\text{ A}$; $I_B = 0.6\text{ A}$; note 1	–	0.75	–	V
f_T	transition frequency	$V_{CB} = 25\text{ V}$; $I_E = -3\text{ A}$; $f = 100\text{ MHz}$; note 2	–	680	–	MHz
	transition frequency	$V_{CB} = 25\text{ V}$; $I_E = -6\text{ A}$; $f = 100\text{ MHz}$; note 2	–	750	–	MHz
C_C	collector capacitance	$V_{CB} = 25\text{ V}$; $I_E = i_e = 0$; $f = 1\text{ MHz}$	–	155	–	pF
C_{re}	feedback capacitance	$I_C = 100\text{ mA}$; $V_{CE} = 25\text{ V}$; $f = 1\text{ MHz}$	–	88	–	pF
C_{cs}	collector-stud capacitance		–	3	–	pF

Notes

1. Measured under pulse conditions: $t_p \leq 300\text{ }\mu\text{s}$; $\delta \leq 0.02$.
2. Measured under pulse conditions: $t_p \leq 50\text{ }\mu\text{s}$; $\delta \leq 0.01$.

VHF linear power transistor

BLV33

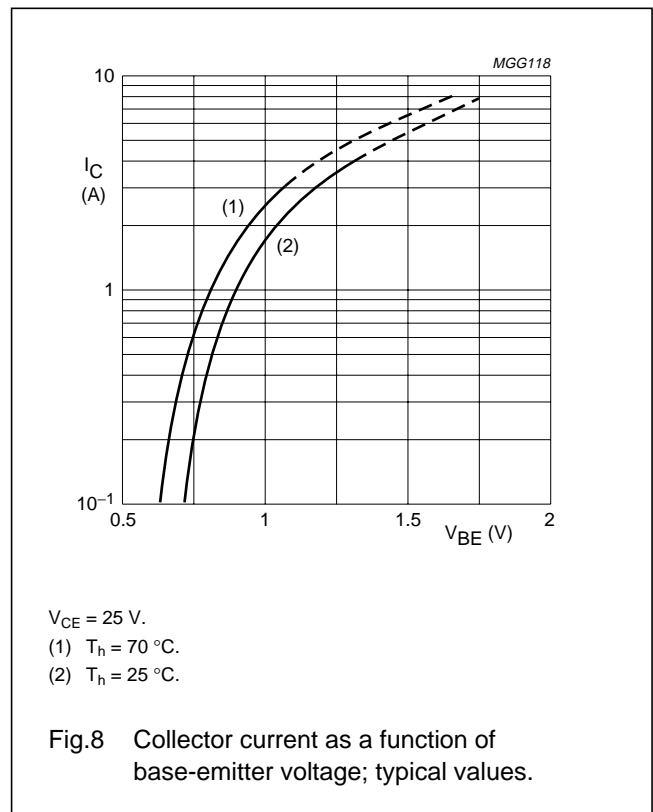
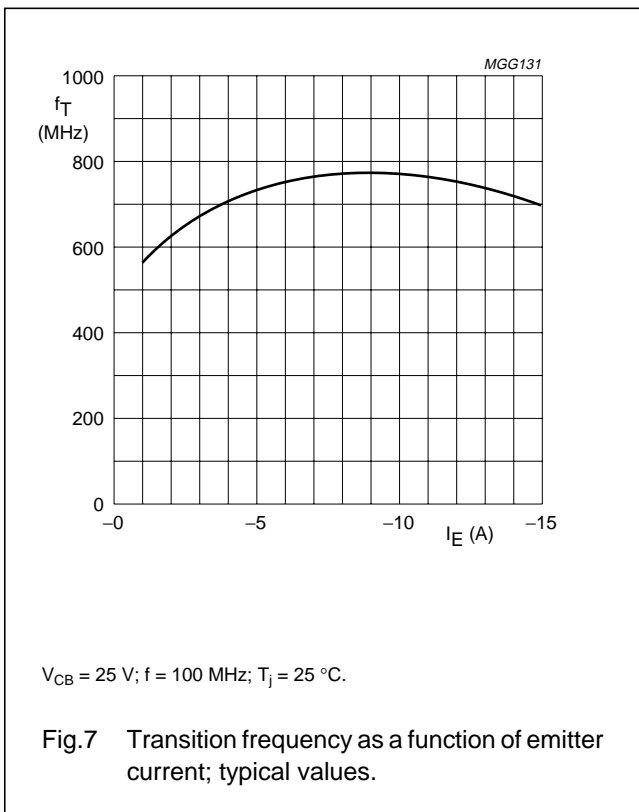
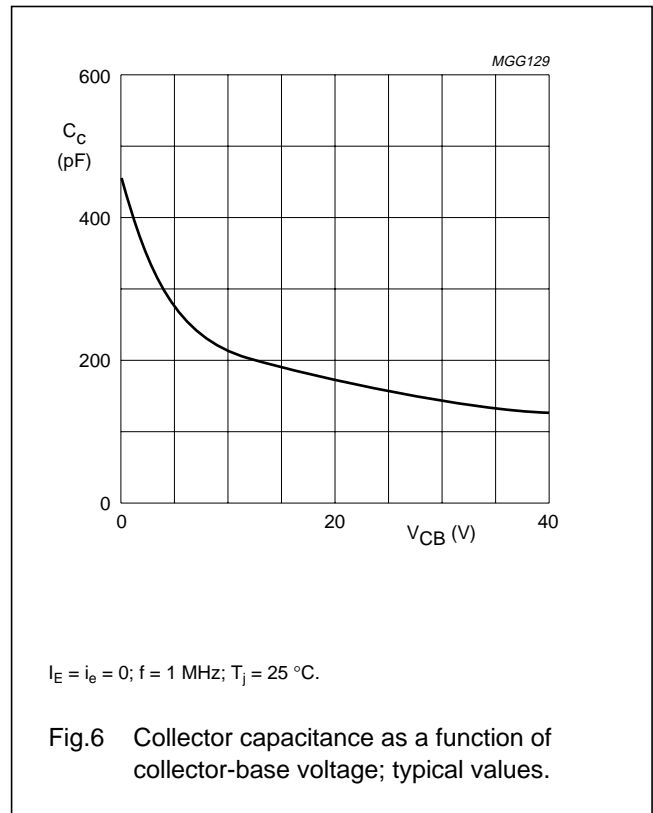
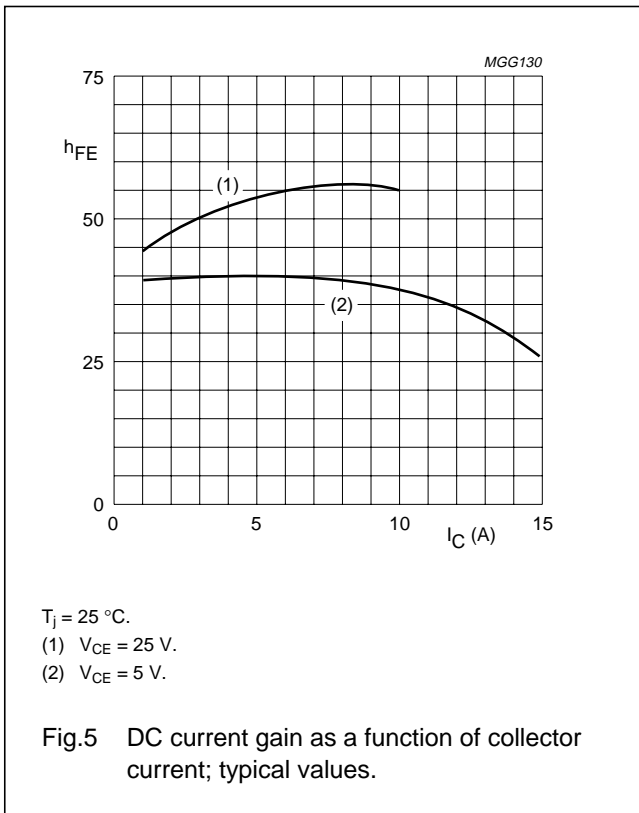

VHF linear power transistor

BLV33

APPLICATION INFORMATION

RF performance in VHF class-A operation (linear power amplifier)

MODE OF OPERATION	f_{vision} (MHz)	V_{CE} (V)	I_{C} (A)	T_{h} (°C)	$d_{\text{im}}^{(1)}$ (dB)	$P_{\text{o sync}}^{(1)}$ (W)	G_{p} (dB)
CW, class-A	224.25	25	3.2	70	-55	>16.5	>9
				70	-55	typ. 17.5	typ. 9.3
				70	-52	typ. 26.5	typ. 9.3
				25	-55	typ. 23	typ. 9.7

Note

1. Three-tone test method (vision carrier -8 dB, sound carrier -7 dB, sideband signal -16 dB), zero dB corresponds to peak sync level.

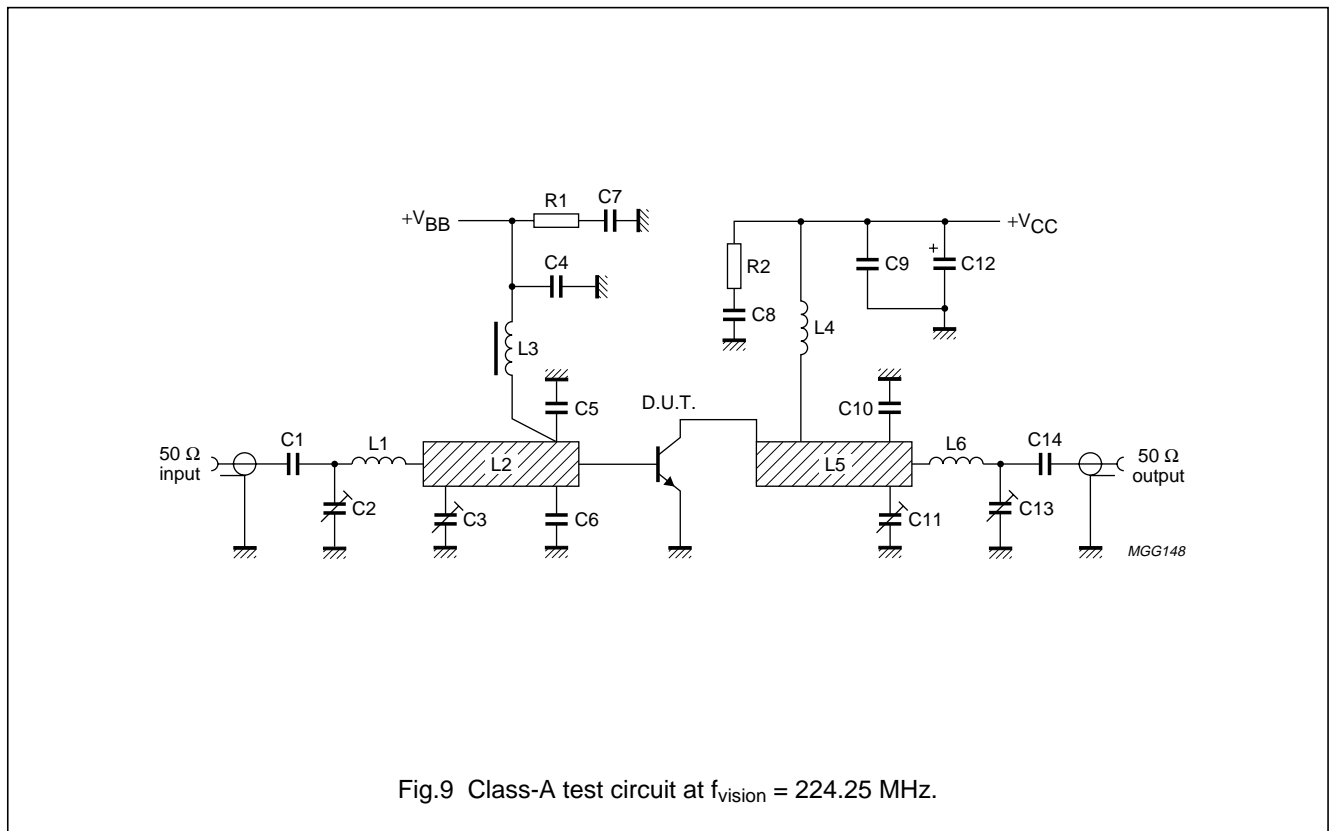

Fig.9 Class-A test circuit at $f_{\text{vision}} = 224.25$ MHz.

VHF linear power transistor

BLV33

List of components used in test circuit (see Figs 9 and 10).

COMPONENT	DESCRIPTION	VALUE	DIMENSIONS	CATALOGUE No.
C1, C14	multilayer ceramic chip capacitor; note 1	680 pF, 500 V		
C2, C11, C13	film dielectric trimmer	4 to 40 pF		2222 809 08002
C3	film dielectric trimmer	2 to 18 pF		2222 809 09003
C4, C9	multilayer ceramic chip capacitor	680 pF, 50 V		2222 852 13681
C5, C6	multilayer ceramic chip capacitor; note 1	68 pF, 500 V	placed 2 mm from transistor edge	
C7, C8	multilayer ceramic chip capacitor	470 nF, 50 V		2222 856 48474
C10	multilayer ceramic chip capacitor; note 1	24 pF, 500 V		
C12	solid aluminium electrolytic capacitor	10 μ F, 40 V		
L1	1½ turns of closely wound 1.6 mm enamelled Cu wire		int. diameter 4.5 mm leads 2 × 3 mm	
L2	stripline	30 Ω	6 mm × 32.7 mm	
L3	microchoke	1 μ H		4322 057 01080
L4	2 turns of 1.1 mm enamelled Cu wire	27 nH	int. diameter 4.5 mm length 2.9 mm leads 2 × 5 mm	
L5	stripline	30 Ω	6 mm × 24 mm	
L6	2 turns of 1.1 mm enamelled Cu wire	19 nH	int. diameter 3.5 mm length 3.5 mm leads 2 × 5 mm	
L2, L5	stripline; note 2			
R1, R2	carbon resistor	10 Ω		

Notes

- American Technical Ceramics type 100B or capacitor of same quality.
- The striplines are on a double Cu-clad printed-circuit board, with epoxy fibre-glass dielectric ($\epsilon_r = 4.5$); thickness $\frac{1}{16}$ ".

VHF linear power transistor

BLV33

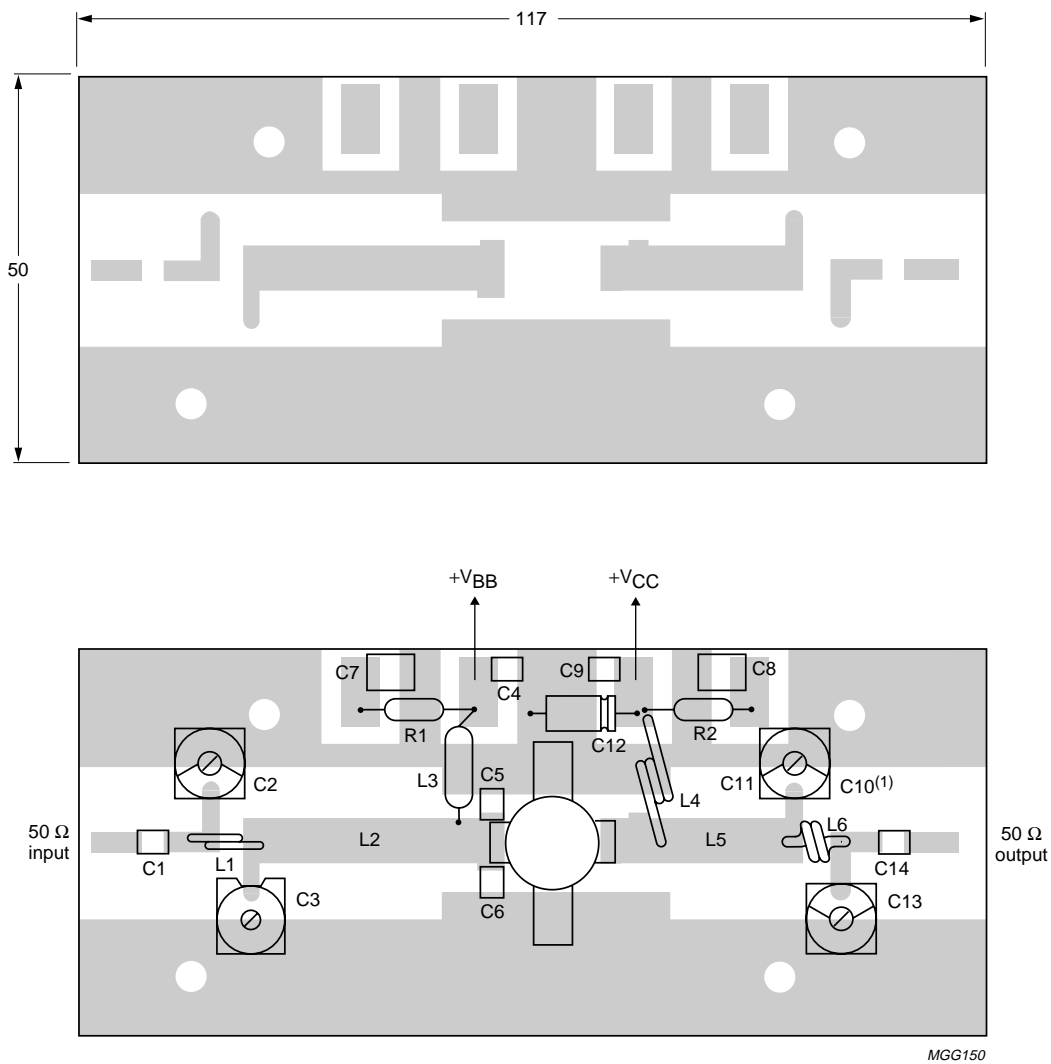

Dimensions in mm.

The circuit and the components are on one side of the epoxy fibre-glass board, the other side is unetched copper to serve as earth. Earth connections are made by hollow rivets. Additionally copper straps are used under the emitters and at the input and output to provide direct contact between the copper on the component side and the ground-plane.

(1) C10 positioned under C11.

Fig.10 Component layout and printed-circuit board for 224.25 MHz class-A test circuit.

VHF linear power transistor

BLV33

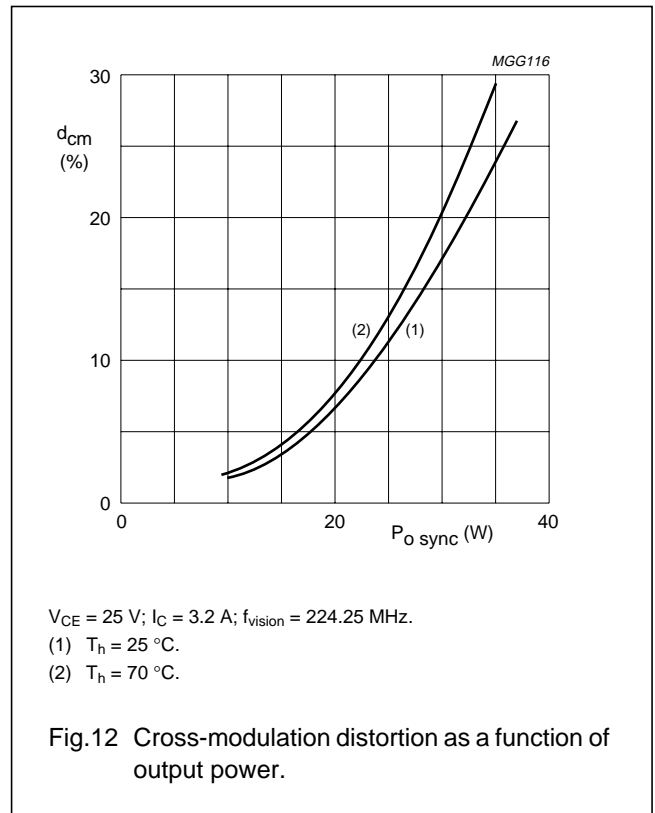
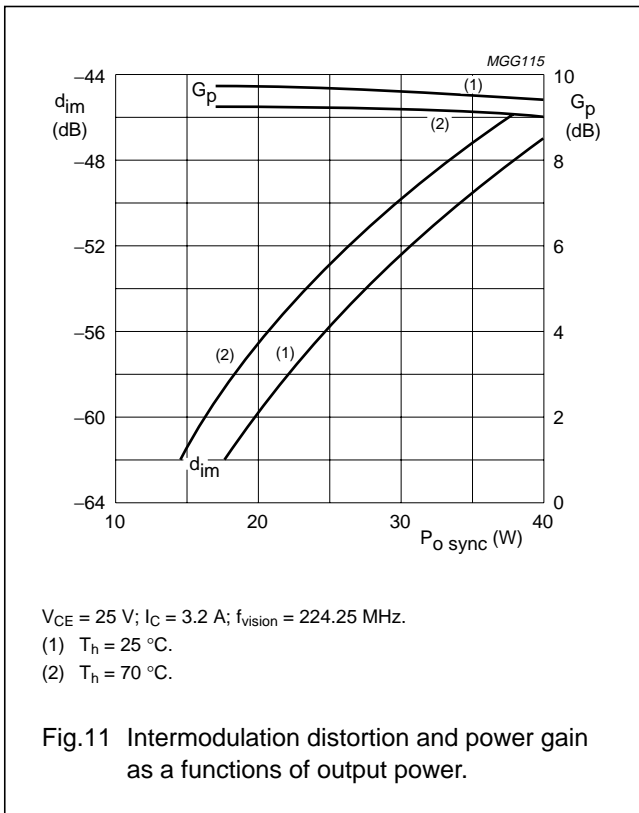

Three-tone test method (vision carrier -8 dB, sound carrier -7 dB, sideband signal -16 dB), zero dB corresponds to peak sync level (see Fig.11).

Two-tone test method (vision carrier 0 dB, sound carrier -7 dB), zero dB corresponds to peak sync level.

Cross-modulation distortion (d_{cm}) is the voltage variation (%) of sound carrier when vision carrier is switched from 0 dB to -20 dB (see Fig.12).

Ruggedness in class-A operation

The BLV33 is capable of withstanding a full load mismatch corresponding to $V_{\text{SWR}} = 50 : 1$ through all phases up to 30 W (RMS) or 40 W (PEP) under the following conditions: $V_{CE} = 25\text{ V}; I_C = 3.2\text{ A}; T_h = 70\text{ }^\circ\text{C}; f = 224.25\text{ MHz}; R_{\text{th mb-h}} = 0.15\text{ K/W}.$

VHF linear power transistor

BLV33

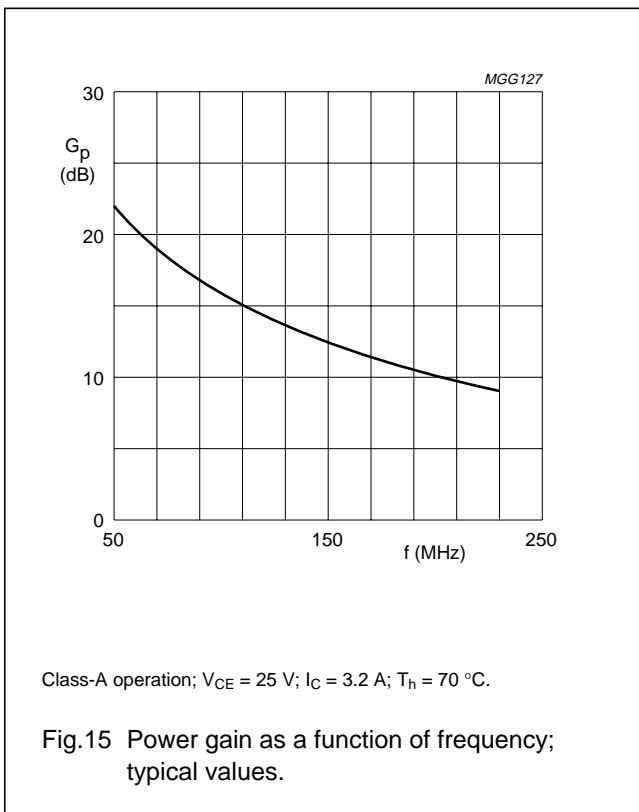
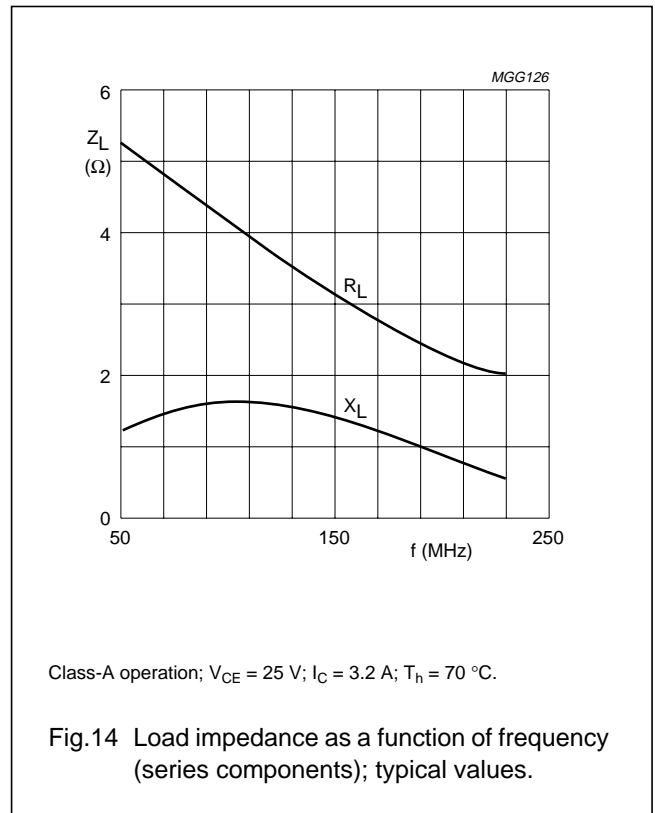
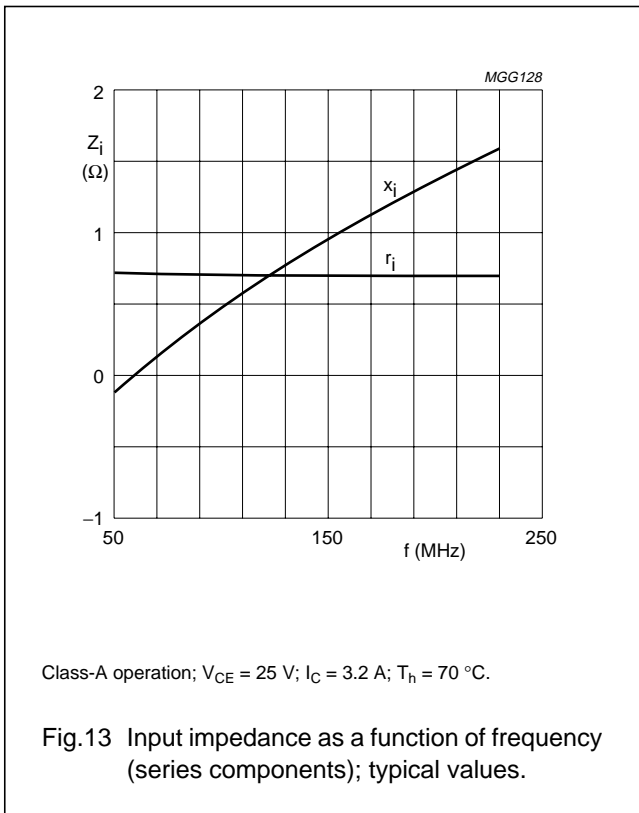

VHF linear power transistor

BLV33

RF performance in VHF class-AB operation (C.W)

MODE OF OPERATION	f (MHz)	V _{CE} (V)	I _c , I _{c(zs)} (A)	T _h (°C)	P _L (W)	I _c (A)	η _c (%)	G _p (dB) ⁽¹⁾
CW, class-AB	224.25	28	0.1	70	40	typ. 2.60	typ. 55	typ. 7.5
					90	typ. 4.46	typ. 72	typ. 6.5

Note

- Gain compression point of 1 dB is at typical 90 W (minimum 80 W). Using a 3rd-order amplitude transfer characteristic, 1 dB compression corresponds with 30 % sync input / 25 % sync output compression in television service (negative modulation, C.C.I.R. system).

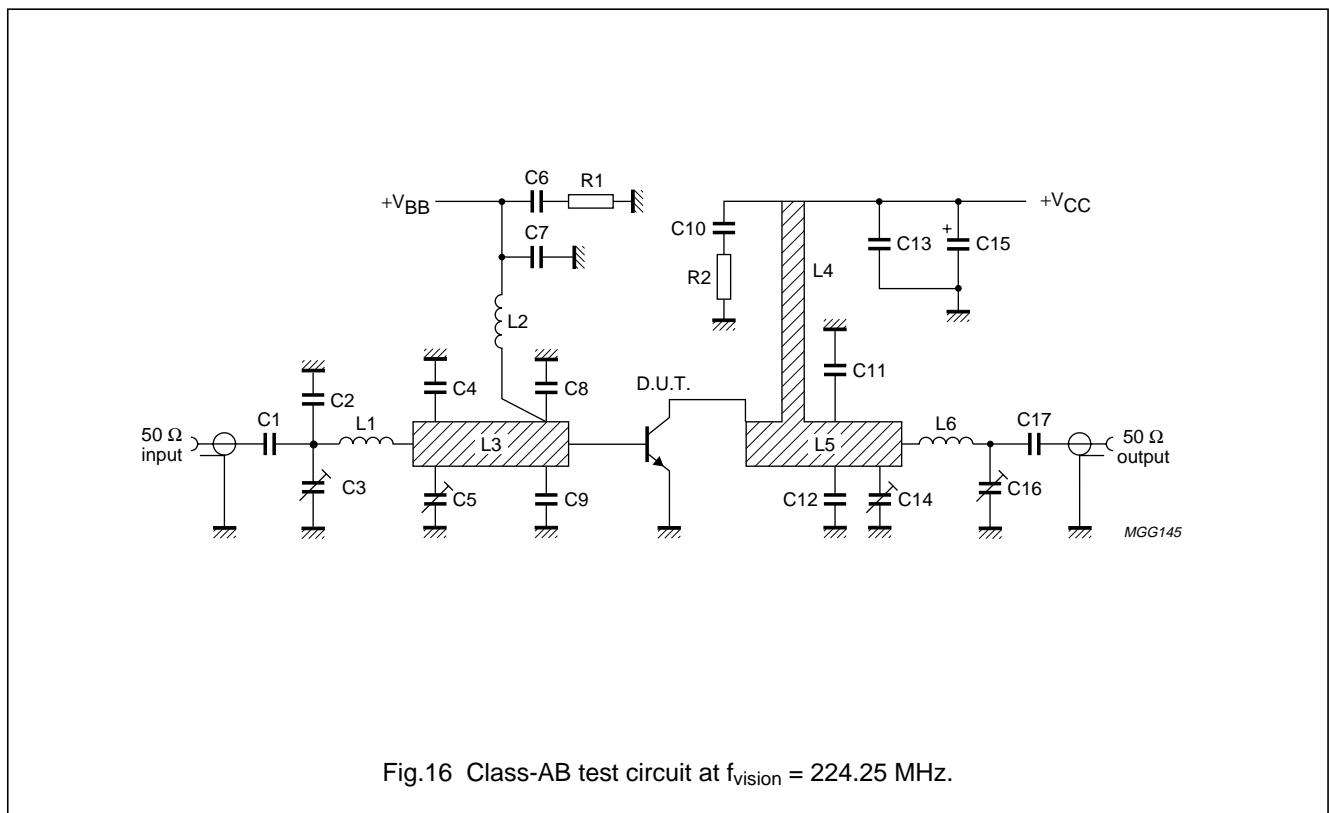

VHF linear power transistor

BLV33

List of components used in test circuit (see Fig.16).

COMPONENT	DESCRIPTION	VALUE	DIMENSIONS	CATALOGUE No.
C1, C17	multilayer ceramic chip capacitor; note 1	680 pF, 500 V		
C2	multilayer ceramic chip capacitor; note 1	39 pF, 500 V		
C3, C16	film dielectric trimmer	2 to 18 pF		2222 809 09003
C4	multilayer ceramic chip capacitor; note 1	43 pF, 500 V		
C5	film dielectric trimmer	4 to 40 pF		2222 809 08002
C6, C10	polyester capacitor	330 nF		
C7, C13	multilayer ceramic chip capacitor	680 pF, 50 V		2222 852 13681
C8, C9	multilayer ceramic chip capacitor; note 1	68 pF, 500 V	placed 2.5 mm from transistor edge	
C11, C12	multilayer ceramic chip capacitor; note 1	27 pF, 500 V	placed 7 mm from transistor edge	
C14	film dielectric trimmer	5 to 60 pF		2222 809 08003
C15	solid aluminium electrolytic capacitor	10 μ F, 40 V		
L1	2 turns of 1.6 mm enamelled Cu wire	25 nH	int. diameter 4.3 mm length 3.4 mm leads 2 \times 5 mm	
L2	4 turns closely wound 1.1 mm enamelled Cu wire	120 nH	int. diameter 6 mm leads 2 \times 5 mm	
L3	stripline; note 2	30 Ω	6 mm \times 48.8 mm	
L4	stripline; note 2	48 Ω	3 mm \times 27 mm at 3 mm from transistor edge	
L5	stripline; note 2	30 Ω	6 \times 42.9 mm	
L6	2 turns of 1.6 mm enamelled Cu wire	24 nH	int. diameter 4 mm length 3.4 mm leads 2 \times 5 mm	
R1, R2	carbon resistor	10 Ω		

Notes

- American Technical Ceramics type 100B or capacitor of same quality.
- The striplines are on a double Cu-clad printed-circuit board, with epoxy fibre-glass dielectric ($\epsilon_r = 4.5$); thickness $1/16$ ".

VHF linear power transistor

BLV33

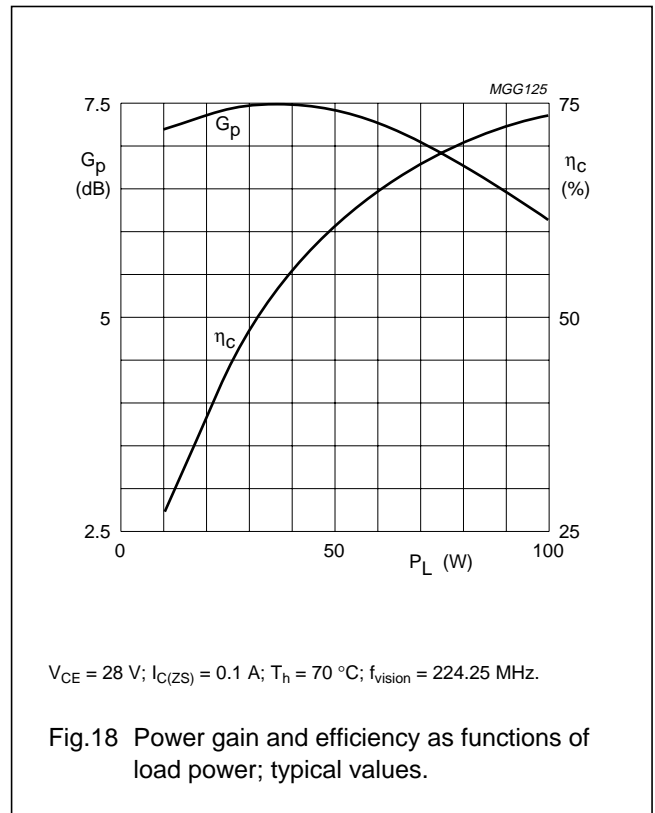
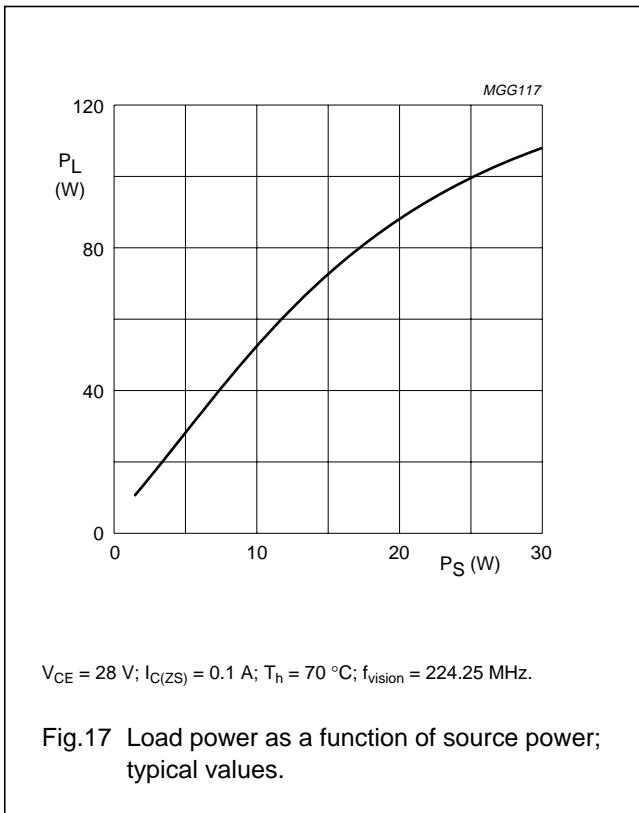

Ruggedness in class-AB operation

The BLV33 is capable of withstanding a full load mismatch corresponding to $VSWR \leq 2$ through all phases) up to 60 W (RMS) and 90 W (PEP) under the following conditions: $V_{CE} = 28\text{ V}; T_h = 70\text{ }^\circ\text{C}; f = 224.25\text{ MHz}; R_{th\text{ mb-h}} = 0.15\text{ K/W.}$

VHF linear power transistor

BLV33

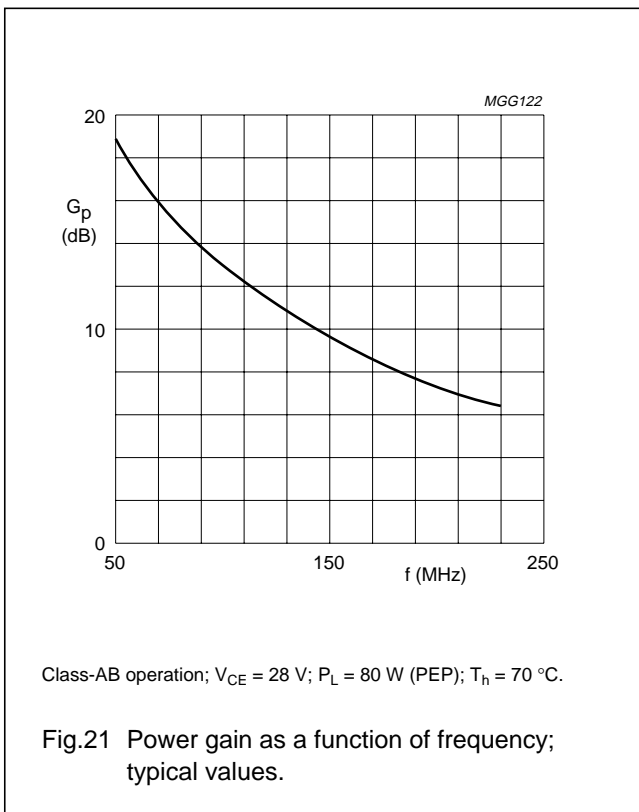
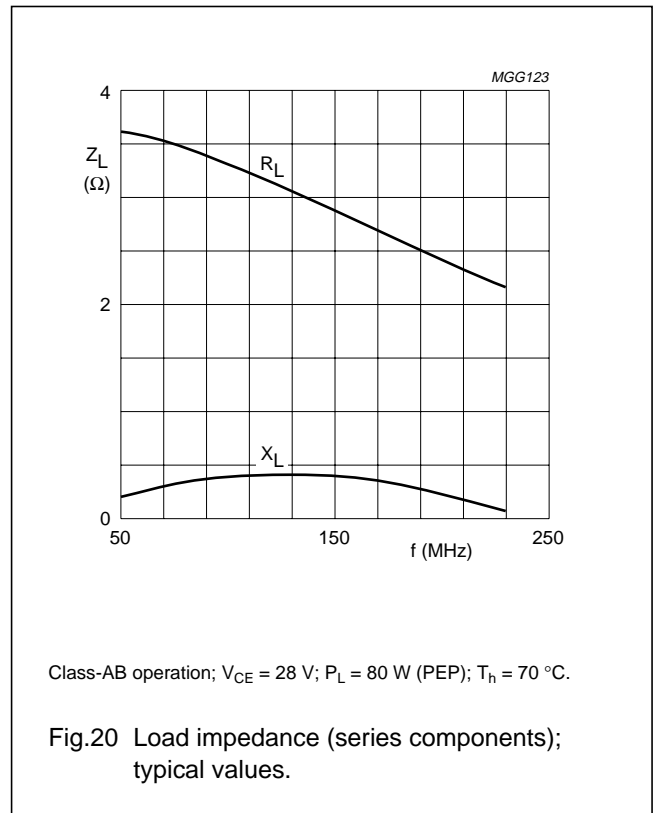
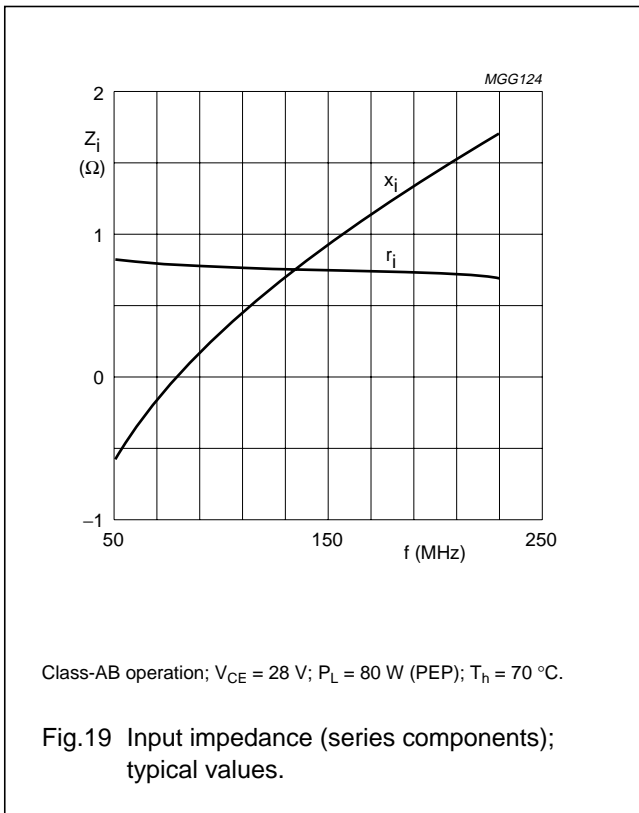

VHF linear power transistor

BLV33

PACKAGE OUTLINE

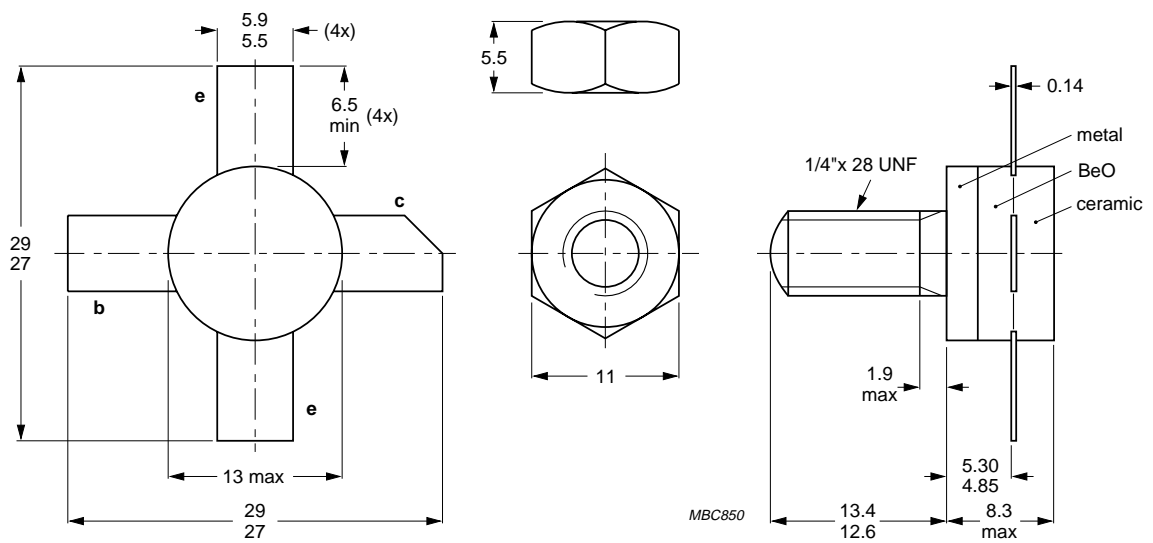

Dimensions in mm.

Torque on nut: min. 2.3 Nm; max. 2.7 Nm.

Diameter of clearance hole in heatsink: max. 6.4 mm.

Mounting hole to have no burrs at either end.

De-burring must leave surface flat; do not chamfer or countersink either end of hole.

When locking is required an adhesive is preferred instead of a lock washer.

Fig.22 SOT147.

VHF linear power transistor

BLV33

DEFINITIONS

Data Sheet Status	
Objective specification	This data sheet contains target or goal specifications for product development.
Preliminary specification	This data sheet contains preliminary data; supplementary data may be published later.
Product specification	This data sheet contains final product specifications.
Limiting values	
Limiting values given are in accordance with the Absolute Maximum Rating System (IEC 134). Stress above one or more of the limiting values may cause permanent damage to the device. These are stress ratings only and operation of the device at these or at any other conditions above those given in the Characteristics sections of the specification is not implied. Exposure to limiting values for extended periods may affect device reliability.	
Application information	
Where application information is given, it is advisory and does not form part of the specification.	

LIFE SUPPORT APPLICATIONS

These products are not designed for use in life support appliances, devices, or systems where malfunction of these products can reasonably be expected to result in personal injury. Philips customers using or selling these products for use in such applications do so at their own risk and agree to fully indemnify Philips for any damages resulting from such improper use or sale.

VHF linear power transistor

BLV33

NOTES

VHF linear power transistor

BLV33

NOTES

Philips Semiconductors – a worldwide company

Argentina: see South America

Australia: 34 Waterloo Road, NORTH RYDE, NSW 2113,
Tel. +61 2 9805 4455, Fax. +61 2 9805 4466

Austria: Computerstr. 6, A-1101 WIEN, P.O. Box 213,
Tel. +43 1 60 101, Fax. +43 1 60 101 1210

Belarus: Hotel Minsk Business Center, Bld. 3, r. 1211, Volodarski Str. 6,
220050 MINSK, Tel. +375 172 200 733, Fax. +375 172 200 773

Belgium: see The Netherlands

Brazil: see South America

Bulgaria: Philips Bulgaria Ltd., Energoproject, 15th floor,
51 James Bourchier Blvd., 1407 SOFIA,
Tel. +359 2 689 211, Fax. +359 2 689 102

Canada: PHILIPS SEMICONDUCTORS/COMPONENTS,
Tel. +1 800 234 7381

China/Hong Kong: 501 Hong Kong Industrial Technology Centre,
72 Tat Chee Avenue, Kowloon Tong, HONG KONG,
Tel. +852 2319 7888, Fax. +852 2319 7700

Colombia: see South America

Czech Republic: see Austria

Denmark: Prags Boulevard 80, PB 1919, DK-2300 COPENHAGEN S,
Tel. +45 32 88 2636, Fax. +45 31 57 1949

Finland: Sinikalliontie 3, FIN-02630 ESPOO,
Tel. +358 9 615800, Fax. +358 9 61580/xxx

France: 4 Rue du Port-aux-Vins, BP317, 92156 SURESNES Cedex,
Tel. +33 1 40 99 6161, Fax. +33 1 40 99 6427

Germany: Hammerbrookstraße 69, D-20097 HAMBURG,
Tel. +49 40 23 53 60, Fax. +49 40 23 536 300

Greece: No. 15, 25th March Street, GR 17778 TAVROS/ATHENS,
Tel. +30 1 4894 339/239, Fax. +30 1 4814 240

Hungary: see Austria

India: Philips INDIA Ltd, Shivsagar Estate, A Block, Dr. Annie Besant Rd.
Worli, MUMBAI 400 018, Tel. +91 22 4938 541, Fax. +91 22 4938 722

Indonesia: see Singapore

Ireland: Newstead, Clonskeagh, DUBLIN 14,
Tel. +353 1 7640 000, Fax. +353 1 7640 200

Israel: RAPAC Electronics, 7 Kehilat Saloniki St, TEL AVIV 61180,
Tel. +972 3 645 0444, Fax. +972 3 649 1007

Italy: PHILIPS SEMICONDUCTORS, Piazza IV Novembre 3,
20124 MILANO, Tel. +39 2 6752 2531, Fax. +39 2 6752 2557

Japan: Philips Bldg 13-37, Kohnan 2-chome, Minato-ku, TOKYO 108,
Tel. +81 3 3740 5130, Fax. +81 3 3740 5077

Korea: Philips House, 260-199 Itaewon-dong, Yongsan-ku, SEOUL,
Tel. +82 2 709 1412, Fax. +82 2 709 1415

Malaysia: No. 76 Jalan Universiti, 46200 PETALING JAYA, SELANGOR,
Tel. +60 3 750 5214, Fax. +60 3 757 4880

Mexico: 5900 Gateway East, Suite 200, EL PASO, TEXAS 79905,
Tel. +9-5 800 234 7381

Middle East: see Italy

Netherlands: Postbus 90050, 5600 PB EINDHOVEN, Bldg. VB,
Tel. +31 40 27 82785, Fax. +31 40 27 88399

New Zealand: 2 Wagener Place, C.P.O. Box 1041, AUCKLAND,
Tel. +64 9 849 4160, Fax. +64 9 849 7811

Norway: Box 1, Manglerud 0612, OSLO,
Tel. +47 22 74 8000, Fax. +47 22 74 8341

Philippines: Philips Semiconductors Philippines Inc.,
106 Valero St. Salcedo Village, P.O. Box 2108 MCC, MAKATI,
Metro MANILA, Tel. +63 2 816 6380, Fax. +63 2 817 3474

Poland: Ul. Lukiska 10, PL 04-123 WARSZAWA,
Tel. +48 22 612 2831, Fax. +48 22 612 2327

Portugal: see Spain

Romania: see Italy

Russia: Philips Russia, Ul. Usatcheva 35A, 119048 MOSCOW,
Tel. +7 095 247 9145, Fax. +7 095 247 9144

Singapore: Lorong 1, Toa Payoh, SINGAPORE 1231,
Tel. +65 350 2538, Fax. +65 251 6500

Slovakia: see Austria

Slovenia: see Italy

South Africa: S.A. PHILIPS Pty Ltd., 195-215 Main Road Martindale,
2092 JOHANNESBURG, P.O. Box 7430 Johannesburg 2000,
Tel. +27 11 470 5911, Fax. +27 11 470 5494

South America: Rua do Rocio 220, 5th floor, Suite 51,
04552-903 São Paulo, SÃO PAULO - SP, Brazil,
Tel. +55 11 821 2333, Fax. +55 11 829 1849

Spain: Balmes 22, 08007 BARCELONA,
Tel. +34 3 301 6312, Fax. +34 3 301 4107

Sweden: Kottbygatan 7, Akalla, S-16485 STOCKHOLM,
Tel. +46 8 632 2000, Fax. +46 8 632 2745

Switzerland: Allmendstrasse 140, CH-8027 ZÜRICH,
Tel. +41 1 488 2686, Fax. +41 1 481 7730

Taiwan: PHILIPS TAIWAN Ltd., 23-30F, 66,
Chung Hsiao West Road, Sec. 1, P.O. Box 22978,
TAIPEI 100, Tel. +886 2 382 4443, Fax. +886 2 382 4444

Thailand: PHILIPS ELECTRONICS (THAILAND) Ltd.,
209/2 Sanpavuth-Bangna Road Prakanong, BANGKOK 10260,
Tel. +66 2 745 4090, Fax. +66 2 398 0793

Turkey: Talatpasa Cad. No. 5, 80640 GÜLTEPE/ISTANBUL,
Tel. +90 212 279 2770, Fax. +90 212 282 6707

Ukraine: PHILIPS UKRAINE, 4 Patrice Lumumba str., Building B, Floor 7,
252042 KIEV, Tel. +380 44 264 2776, Fax. +380 44 268 0461

United Kingdom: Philips Semiconductors Ltd., 276 Bath Road, Hayes,
MIDDLESEX UB3 5BX, Tel. +44 181 730 5000, Fax. +44 181 754 8421

United States: 811 East Arques Avenue, SUNNYVALE, CA 94088-3409,
Tel. +1 800 234 7381

Uruguay: see South America

Vietnam: see Singapore

Yugoslavia: PHILIPS, Trg N. Pasica 5/v, 11000 BEOGRAD,
Tel. +381 11 625 344, Fax. +381 11 635 777

For all other countries apply to: Philips Semiconductors, Marketing & Sales Communications,
Building BE-p, P.O. Box 218, 5600 MD EINDHOVEN, The Netherlands, Fax. +31 40 27 24825

Internet: <http://www.semiconductors.philips.com>

© Philips Electronics N.V. 1996

SCA52

All rights are reserved. Reproduction in whole or in part is prohibited without the prior written consent of the copyright owner.

The information presented in this document does not form part of any quotation or contract, is believed to be accurate and reliable and may be changed without notice. No liability will be accepted by the publisher for any consequence of its use. Publication thereof does not convey nor imply any license under patent- or other industrial or intellectual property rights.

Printed in The Netherlands

127041/1200/01/pp20

Date of release: 1996 Oct 10

Document order number: 9397 750 01033

Let's make things better.

Philips
Semiconductors



PHILIPS